





## LIMPID LIGHTS

COLLECTION 2015

Do we understand what happens when we dim the lights?

This collection started with a curiosity about how can we integrate dimming as a part of the design and incorporates movement as a central element of the light?

Limpid Lights continues on the idea of manipulating the light with movement. By moving the light-source closer to, or further away from the lighting object, the intensity of the light can be adapted. While the initial LED-light is fresh and bright, the handblown glass shades can be used to soften the light and create a more intimate ambiance. By moving the light source, the light can be playfully adapted from bright to a more diffuse, soft and/or coloured light.

Limpid Light comes in three shapes - small, medium and large -. You can choose between two glass colors: Clear and Smoke. Custom colour finish is possible for larger order quantities. There are two types of suspension available: Full Swing and Standard. The Full Swing version provides the total package including an adjustable LED with two counterweights keeping the light at a desired position. The Standard version embodies the essential simplified setup without counterweights, which could be more suitable for public environments as a bar or hotel.

LIMPID LIGHT L  
Smoked glass  
Full Swing



## LIMPID LIGHTS COLOURED

COLLECTION 2020

Through all the collaboration with architects, interior architects, designers, and stylists around the world, we figured a way to color the Limpid Lights in custom colors. The light objects are made by people instead of machines as well as the shades, and the colors are added with a special technique. As you will notice the color is not a paint, but there is made use of a new nano technique. This way we are not obliged to use a colored glass, the glass is transparent and get's a matte colored surface.

LIMPID LIGHT S  
Clear glass  
Color Coral  
Full Swing

# CREATING DIFFERENT COLOUR SHADES



LIMPID LIGHTS

LIMPID LIGHTS

Model S Rosequartz, Model M smoked glass, Model S Rosequartz, Model L Coral, Model S Coral, All Full Swing



VANTOT

## SAMPLES

### CUSTOMISED COLOURS

These are coloured glass samples made to provide some of the colour's possibilities aim to help our customers choose the most suitable colours for their interior design. Unique lighting can make the setting become very outstanding. Though not every colour is possible, there are endless possibilities.

Which gives us the freedom to create unique lighting together in different approaches. For example, you can have a set of 4 Limpid Lights in 4 different kinds of blue from the lightest to the darkest blue.



VANTOT

# LIMPID LIGHTS AT CROWN RESIDENCE, SYDNEY



LIMPID LIGHTS

LIMPID LIGHTS

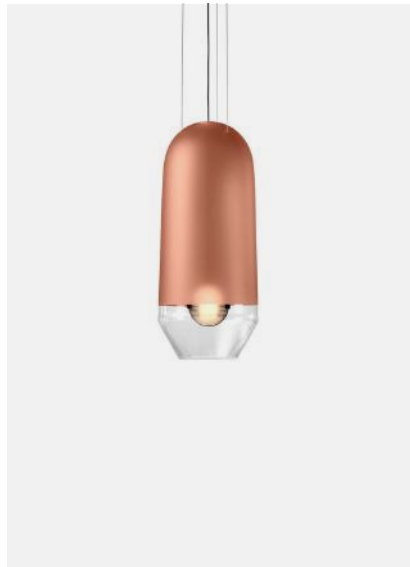

LIMPID LIGHT  
Clear glass, Coloured S  
Standard



LIMPID LIGHT  
Clear glass S  
Full Swing



LIMPID LIGHT  
Clear glass L  
Standard



LIMPID LIGHT  
Smoked glass S  
Full Swing



LIMPID LIGHT  
Clear glass M  
Full Swing



LIMPID LIGHT  
Clear glass L  
Full Swing



LIMPID LIGHT  
Smoked glass M  
Full Swing



LIMPID LIGHT  
Smoked glass L  
Full Swing



LIMPID LIGHT S COLOURED  
Tanzanite  
Full Swing



LIMPID LIGHT S COLOURED  
Bluequartz  
Full Swing



LIMPID LIGHT S COLOURED  
Graphite  
Full Swing



LIMPID LIGHT S COLOURED  
Azure  
Full Swing



LIMPID LIGHT S COLOURED  
Coral  
Full Swing



LIMPID LIGHT S COLOURED  
Bronzite  
Full Swing



LIMPID LIGHT S COLOURED  
Rosequartz  
Full Swing



LIMPID LIGHT S COLOURED  
Jade  
Full Swing





## HANDBLOWN GLASS

CZECH REPUBLIC, EUROPE

All products are made in Europe with the highest quality because we want to contribute to better surroundings in the first place. A centralized location in Europe with a rich history regarding glass blowing and sufficient resources, the Czech Republic has become our choice of manufacturing.

Czech glassmakers perfected their craft skills throughout the Middle Ages and this also applied to the raw material they worked with. Because of technological improvements, Czech glass became a highly demanded commodity in the transalpine Renaissance. It is as famous as the Venetian glass which is considered the peak of glassmaking to this day.

Since then, the Czech glassmaking has developed and invented new possibilities and made use of new materials. Due to the quality and development, Czech glass fairly maintained its position until this day.

The Czech Republic holds an indispensable place in the modern history of glass-making, many technologies that were developed by Czech glassmakers are now used all over the world.

At VANTOT quality is our priority, the production process is essentially important. Therefore, we spent time in the Czech Republic learning how our products are made and contributed countless hours choosing the right manufacturer for the “Limpid light”.

Limpid Light  
production  
Czech Republic  
March 2020

# DIFFUSED LIGHT WITH MATTE GLASS



LIMPID LIGHTS

LIMPID LIGHTS

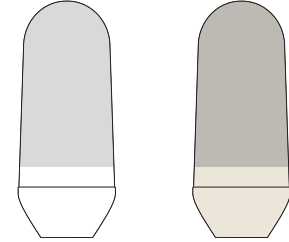

## LIMPID LIGHT S SPECS

CODES	#080 - CLEAR GLASS #097 - SMOKED GLASS
LIGHT SOURCE	LED Integrated 4,8 W 2700 K 600 lm CRI 90
DIMENSIONS	166 x 166 x 385 mm (l x w x h) Package 300 x 420 x 1000 mm (l x w x h)
NETTO WEIGHT	2 kg
MATERIALS	Shade in glass (the glass is mouth blown and therefore can contain airbubbles). Adjustable suspension in steel and brass. Non adjustable suspension in steel.
FINISH	 <p>Clear glass sandblasted Smoked glass sandblasted * with fingerprint protective finish</p>
VERSIONS	#004 - Standard, Fixed suspension #011 - Full Swing, Adjustable suspension
DIMMABLE DRIVER	Dimmer not included



LIMPID LIGHTS

LIMPID LIGHTS

## LIMPID LIGHT M SPECS

CODES	#707 - CLEAR GLASS #714 - SMOKED GLASS
LIGHT SOURCE	LED Integrated 4,8 W 2700 K 600 lm CRI 90
DIMENSIONS	340 x 340 x 360 mm (l x w x h) Package 450 x 450 x 650 mm (l x w x h)
NETTO WEIGHT	2 kg
MATERIALS	Shade in glass (the glass is mouth blown and therefore can contain airbubbles). Adjustable suspension in steel and brass. Non adjustable suspension in steel.

### FINISH

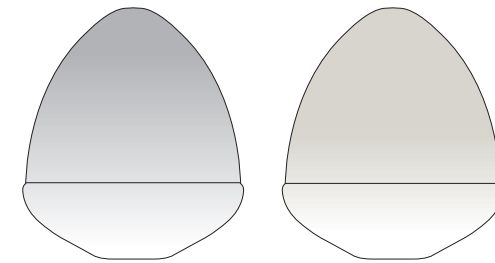

Clear glass  
sandblasted

Smoked glass  
sandblasted

\* with fingerprint protective finish

VERSIONS	#004 - Standard, Fixed suspension #011 - Full Swing, Adjustable suspension
----------	---

DIMMABLE DRIVER Dimmer not included



VANTOT

## LIMPID LIGHT L SPECS

CODES	#684 - CLEAR GLASS #677 - SMOKED GLASS
LIGHT SOURCE	LED Integrated 4,8 W 2700 K 600 lm CRI 90
DIMENSIONS	200 x 200 x 600 mm (l x w x h) Package 300 x 420 x 1000 mm (l x w x h)
NETTO WEIGHT	2 kg
MATERIALS	Shade in glass (the glass is mouth blown and therefore can contain airbubbles). Adjustable suspension in steel and brass. Non adjustable suspension in steel.

### FINISH

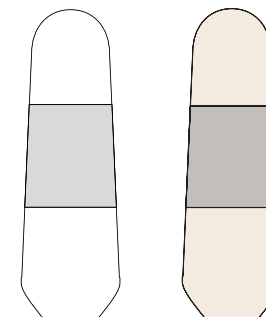

Clear glass  
sandblasted

Smoked glass  
sandblasted

\* with fingerprint protective finish  
matte glass can have the colour requested

VERSIONS	#004 - Standard, Fixed suspension #011 - Full Swing, Adjustable suspension
----------	---

DIMMABLE DRIVER Dimmer not included

## VERSIONS

### COATING

Matte black  
\*white on request

Please note: This light needs to be dimmed (tronic dimmable).  
Dimmer is not included, we suggest the Casambi dimmer + € 70,00

Standard  
fixed LED

Full Swing  
moving LED

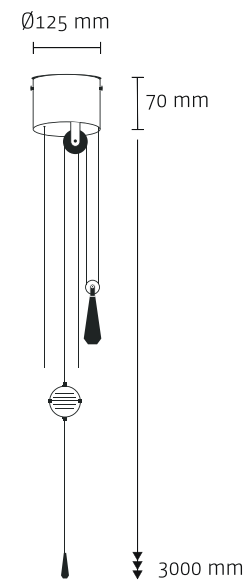
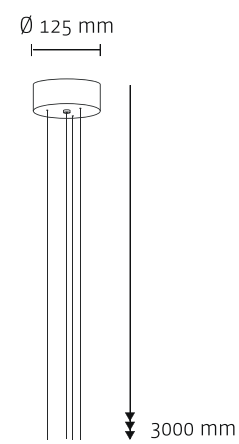



VANTOT

## LIMPID LIGHT COLOURED SPECS

CODES	#127 - GLASS SHADE S #970 - GLASS SHADE L
LIGHT SOURCE	12 W 2700 K 1200 lm CRI 80
DIMENSIONS	166 x 166 x 385 mm (l x w x h) Package 300 x 420 x 1000 mm (l x w x h)
MATERIALS	Shade in glass (the glass is mouth blown and therefore can contain airbubbles). Adjustable suspension in steel and brass. Non adjustable suspension in steel.
FINISH	 <p>Clear glass Sandblasted * with fingerprint protective finish matte glass can have the colour requested</p>
VERSIONS	#004 - Standard, Fixed suspension #011 - Full Swing, Adjustable suspension
DIMMABLE DRIVER	Dimmer not included

## VERSIONS

PACKAGE	Standard	Full Swing
	1 BOX 415 x 290 x 785 mm	1 BOX 415 x 290 x 785 mm
	Gross weight 5,6 kg	Gross weight 5,6 kg
	Net weight 4,6 kg	Net weight 4,6 kg

COATING

Matte black  
 \*white on request  
 Please note: This light needs to be dimmed (tronic dimmable).  
 Dimmer is not included, we suggest the Casambi dimmer + € 70,00

Standard fixed LED	Full Swing moving LED
-----------------------	--------------------------

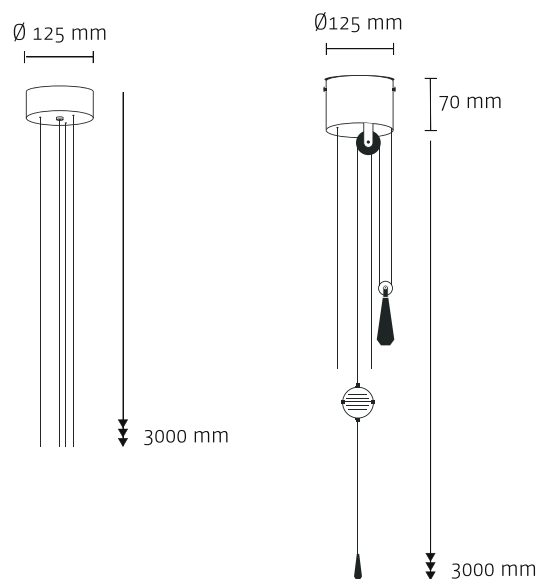

## COLOURS

DIFFERENT COLOURS ON REQUEST



Pyrite



Azure



Coral



Bronzite



Bluequartz



Rosequartz



Graphite



Jade



Tanzanite



## DISCOVER

VANTOT works in translating innovative and experimental ideas into refreshing applications, products, and installations. Sometimes, products are made on request as a project. We are specialized in lighting and also creating other products in different categories which will be shown in the following content.

Click on the image for more information, catalog, high resolution photo's, technical info and 3D-files.

## INDOOR LIGHTING

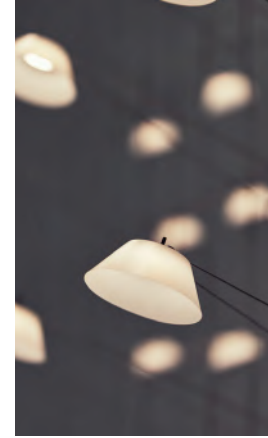

LIIU



MONO



O-O-O

## CUSTOM INSTALLATIONS



CUSTOM O-O-O  
A Stellar Light Installation  
Australia



CUSTOM LIIU  
CLUB ACE  
The Netherlands



CUSTOM V-V-V  
Mexico



COSMOS

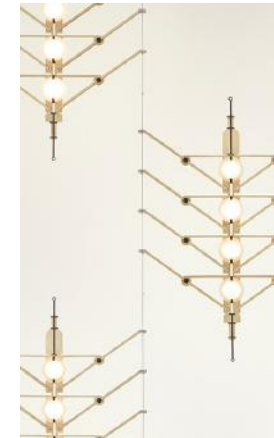

V-V-V



EXPLODED VIEW

# VANTOT; CONTRIBUTING TO THE TRANSITION OF LIGHT

SAM VAN GURP & ESTHER JONGSMA



LIMPID LIGHTS

LIMPID LIGHTS

## VANTOT

For Dutch duo VANTOT, it's all in the name. Literally translated from Dutch to mean 'from to', VANTOT focuses on the entire process, starting with a technique and ending with the product. The pair strives to find new applications for innovations in everyday life, and it's not only new-found technologies which have seized their interest. Serving as a guiding light in the duo's work, antiquated techniques are put to good use in modern day outlets, mutually benefiting from today's updated knowledge base.

Take electricity. Although light bulbs have been around for centuries, innovations – such as the rise of the LEDs – have made continuous evolution possible. And today, electronic devices operate on much lower voltages than ever before, significantly decreasing its hazardous aspects. While direct contact with electricity – and light – used to be a no go, recent developments illuminate completely new realms for the old technology.

VANTOT

Nassausingel 26 | 4811 DG Breda, The Netherlands  
+31 76 7002134 | [info@vantot.com](mailto:info@vantot.com) | [www.vantot.com](http://www.vantot.com)

© VANTOT | [terms and conditions](#) | [delivery and returns](#) | [cookies](#) | [privacy policy](#)

Portrait photo Ruud Balk | Photography Spence&Lyda, Ronald Smits

v6 July 2023